

SHOWLED

animation



ShowLED Animation user manual

Table of Content

Chapter 1: System overview and description.....	3
System overview – typical setup	3
Description of the components.....	4
Chapter 2: The controller.....	5
Safety instructions.....	5
How to replace the fuses.....	5
Connect curtain to controller and PC.....	6
Operator Console	7
The Status display.....	8
Message list	9
Bit field decoding.....	9
Technical Specifications.....	10
Declaration of conformity	12
Chapter 3: The ShowLEditor.....	13
Software download	13
Configuring the PC's IP address (Windows XP)	14
Configuring the PC's IP address (Windows Vista)	17
ShowLEditor software.....	21
Empty spaces.....	23
Error notices	25
Chapter 4: The V-Box.....	26
The V-box three step set-up: 1 Connect - 2 Upload - 3 Play	26
How to upload the configuration file to the V-box?	27
Troubleshooting V-box upload problem	28

Chapter 1: System overview and description

System overview - typical setup

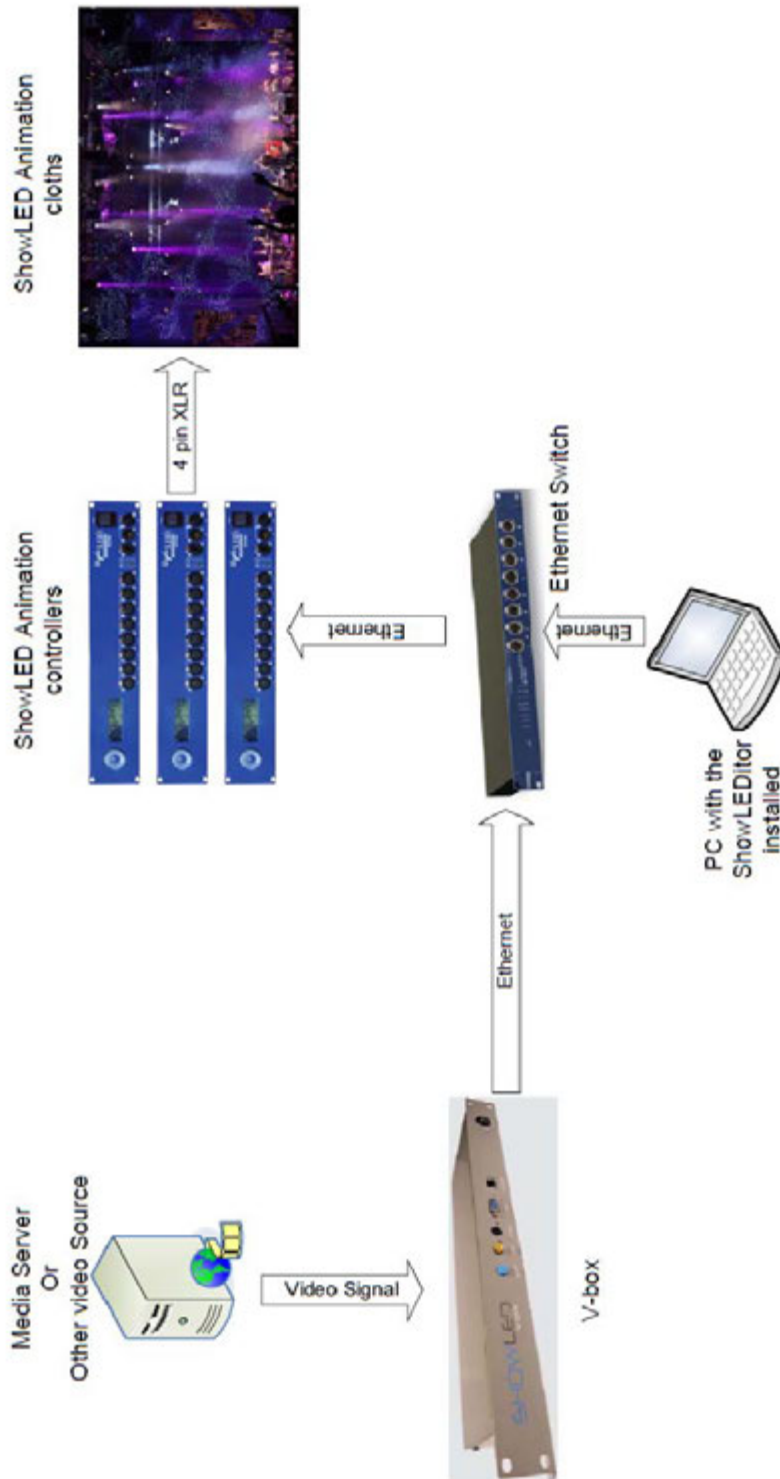

Description of the components

- (1) **Portable computer** with ShowLED Animation designer software installed.

All software needed to control the ShowLED Animation curtain is included in the purchase price.

- (2) **Luminex gigabit switch.**

The laptop or Media server needs to be connected with an Ethernet cable to the ShowLED controller. If more controllers are in process they need to be linked to each other via an Ethernet hub. This Ethernet hub is the Luminex Gigabit Switch and is mounted in the standard 19" touring rack.

More info on the Luminex Gigabit Switch can be found on www.luminex.be.

- (3) **ShowLED Animation controller.**

Custom build controller.

A single controller is stored in a custom made, truss mountable flightcase.

If there is more than 1 controller supplied the controllers are mounted in a custom made touring rack.

More information is available in the section 'technical specifications'.

- (4) **Power distribution and switch.**

When the controllers are mounted in a touring rack, main power can be turned on/off

by using the power switch.

- (5) **Extension cables**

The controllers can be connected to the curtains by optional custom made **extension cables**.

- (6) **ShowLED Animation starcloths**

The "standard" ShowLED Animation starcloths have a dimension of 4m x 9m, 12m x 3m and 5m x 7m. These curtains have 1024 LED's in total so each curtain needs to be connected to a single controller. Animation curtains are shipped in a custom made ShowLED flight case

Chapter 2: The controller

Safety instructions

WARNING

To avoid electric shock the power cord protective grounding must be connected to ground.

Make sure you understand the function of each connection before you connect it. See that all connections are made correctly before turning on the controller.

Always disconnect the controller from the mains supply when connecting the signal leads, the power cord should be connected last.

Do not apply voltage higher than 250 Vac to the controller. (See also technical data)

The controller has a fuse accessible on the IEC power inlet; replace them only with the correct type. See below how to replace them.

To insure good ventilation in order to prevent fire caused by overheating, do not install or use the controller in a closed space. Make sure that the ventilation exits at the side and the back of the controller are not blocked.

Take care with the environmental limits. Do not exceed them. (See technical data)

Keep a minimum distance of 1 meter between you (or the audience) and the LEDs.

Do not stare into the LEDs, especially when narrow angle LEDs are used.

This controller is designed and tested for driving LEDs; do not use it for other purposes.

Do not expose the controller to water (rain) or direct sunlight.

Do not subject to excessive shock by dropping the unit.

How to replace the fuses

Disconnect the power cord! Pull out the fuse drawer below the mains input and replace the fuse at the back of the fuse drawer with the spare fuse at the front of the fuse drawer. If there is no spare fuse use the right kind of fuses. (Fuse, slow blow 6.3A, 20x5*mm). Connect the power cord and check if the controller is working properly.



Should you encounter any problems operating the ShowLED Animation curtain please contact ShowLED FZC. at +971(0)655.783.07 or support@showled.com



Never try to open up/repair the Animation curtain without consulting our technicians.

Connect curtain to controller and PC

- Curtain and controller are transported in blue ShowLED flight cases.
- The controller is likewise built in a special designed storage case. When removing front and back lid of the controller flight case, you will notice that there is a truss clamp for easy attachment of controller to truss or tube. Alternatively, the controller can be placed on the ground.
- It's also possible that the controllers are installed in a 19' touring rack. Please remove front and back lid of the touring rack.
- Included in the flight case are extension cables, the length of these cables depends on the surface of the curtain. These cables can be used if there's a big distance between the cables coming out of the curtain and the controller. Simply connect extension cables to cables coming out of the curtain.
- Connect plugs to controller.
The plugs are not hot swappable, always make sure the controller is turned off when you insert the plugs.

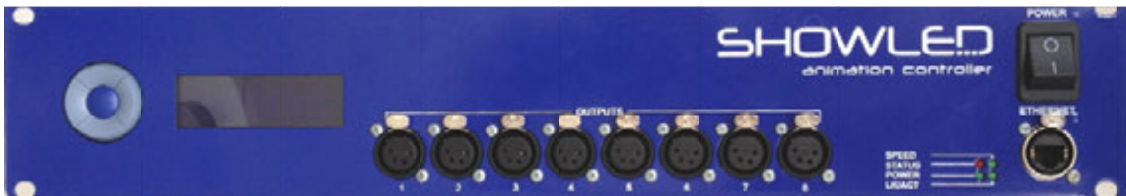

- *Please note that for now only the eight plug inputs and the Ethernet input are functional. The DMX in/output doesn't operate yet.*
- Connect power cord of controller to power supply.
- Link controller via Ethernet cable to PC.
- Switch controller ON. The controller will detect the inserted plugs. If you've attached 8 plugs the display should read "READ SUCCES" 8 times. Then display should read 8 PLUGS DETECTED.
- Continue with Manual ShowLEDitor



Should you encounter any problems operating the ShowLED Animation curtain please contact ShowLED FZC. at +971(0)655.783.07 or support@showled.com

Never try to open up/repair the Animation curtain without consulting our technicians.



Operator Console



The operator console consists of a LCD display and a keypad with five push buttons.

This console is the physical interface that lets you access the menu structure. The menu structure lets you modify the parameters of the controller.

Use the buttons (Up, Down, Left and Right) to scroll through the menu structure.

The UP button lets you scroll up in the menu structure or increase a parameter.

The DOWN button lets you scroll down or decrease a parameter.

The LEFT button lets you go back in the menu structure.

The RIGHT button lets you to select or to confirm a menu item.

Press the UP button and then the DOWN button to unlock the keypad.

The Status display

After powering on the device the LCD displays the controller status.

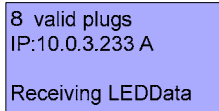

```
8 valid plugs
IP:10.0.3.233 A
Receiving LEDData
```

Status display, line 1

Displays the number of valid plugs detected.

This should be the same amount of plugs connected to the controller.

e.g. 8 valid plugs

Status display, line 2

This line displays the IP-address that the controller has on the Ethernet network.

The letter directly after the address reveals the type of addressing.

A stands for automatic IP addressing

S stands for static IP addressing

D stands for dynamic IP addressing (by means of a DHCP)

Status display, line 3

Most of the time, this will be a blank line.

In a special case this line will display the number of 'blank plugs detected' (see also repair procedure)

Another special case is the message 'Make redundant now!'.

When you see this message it's advisable to do this by following the *Main Menu/Utilities/ Create redundancy* branch of the menu structure.

Status display, line 4

The last line is reserved for system messages.

A message can be neutral or be an error message.

Note, this line can also be blank.

e.g. Receiving LEDData

Message list

message	meaning
Receiving LEDData	The controller receives Ethernet data meant for projection to the animation cloth connected to it.
No Ethernet Link	There is no working Ethernet link with this controller. Please check cables and network gear to resolve this problem.
DON'T HOT SWAP PLUGS	The controller has detected a power surge on one of his output ports. It's most probable caused by inserting a plug in an output port while the device is powered. It's advisable to only plug in connectors when the device is powered off.
OC on port xyz	There is an over current on the ports 'xyz'. See the troubleshoot manual to resolve this. e.g. OC on port 257
one supply fails	One of the internal power supplies fails. See the troubleshoot manual to resolve this.
Fan 1 fails	Fan 1 is jammed, broken or the cable has come loose.
Fan 2 fails	Fan 2 is jammed, broken or the cable has come loose.
Fan 1&2 fails	Both fans are jammed, broken or the cables have come loose.
Temp too high	The cabinet temp is too high. Please resolve this problem. Make sure that the ventilation inlets (two sides) and ventilation outlets (back) are free.
S00000000 X11111111	When there is more than one error at same time this bit field notation is used.

Bit field decoding

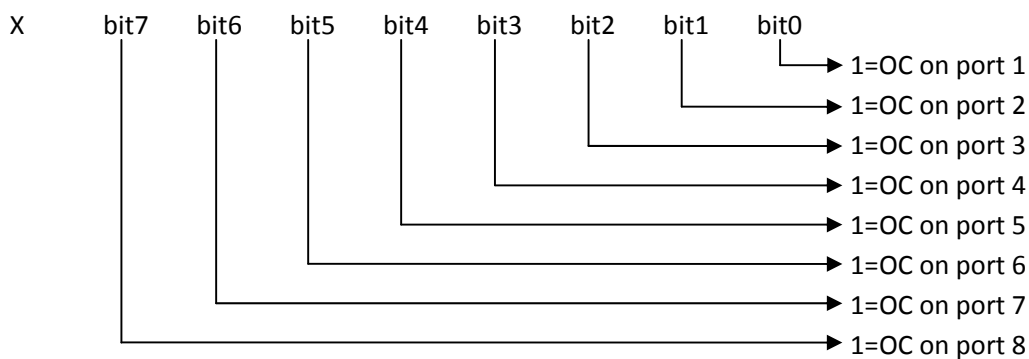
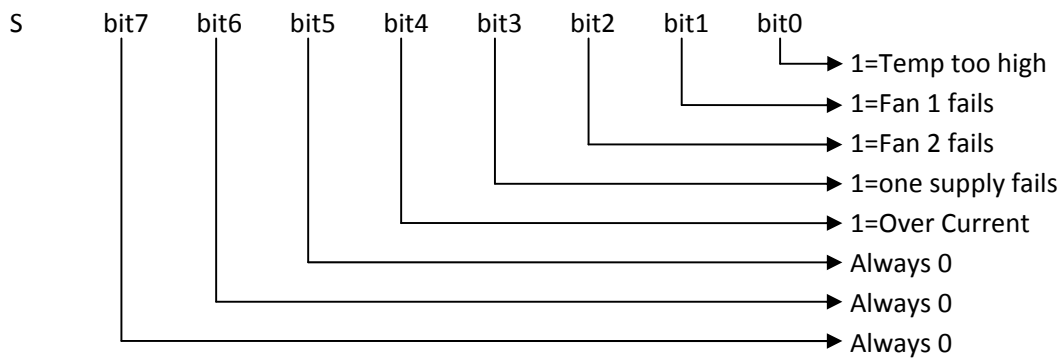

Menu structure

Active menu

Status display

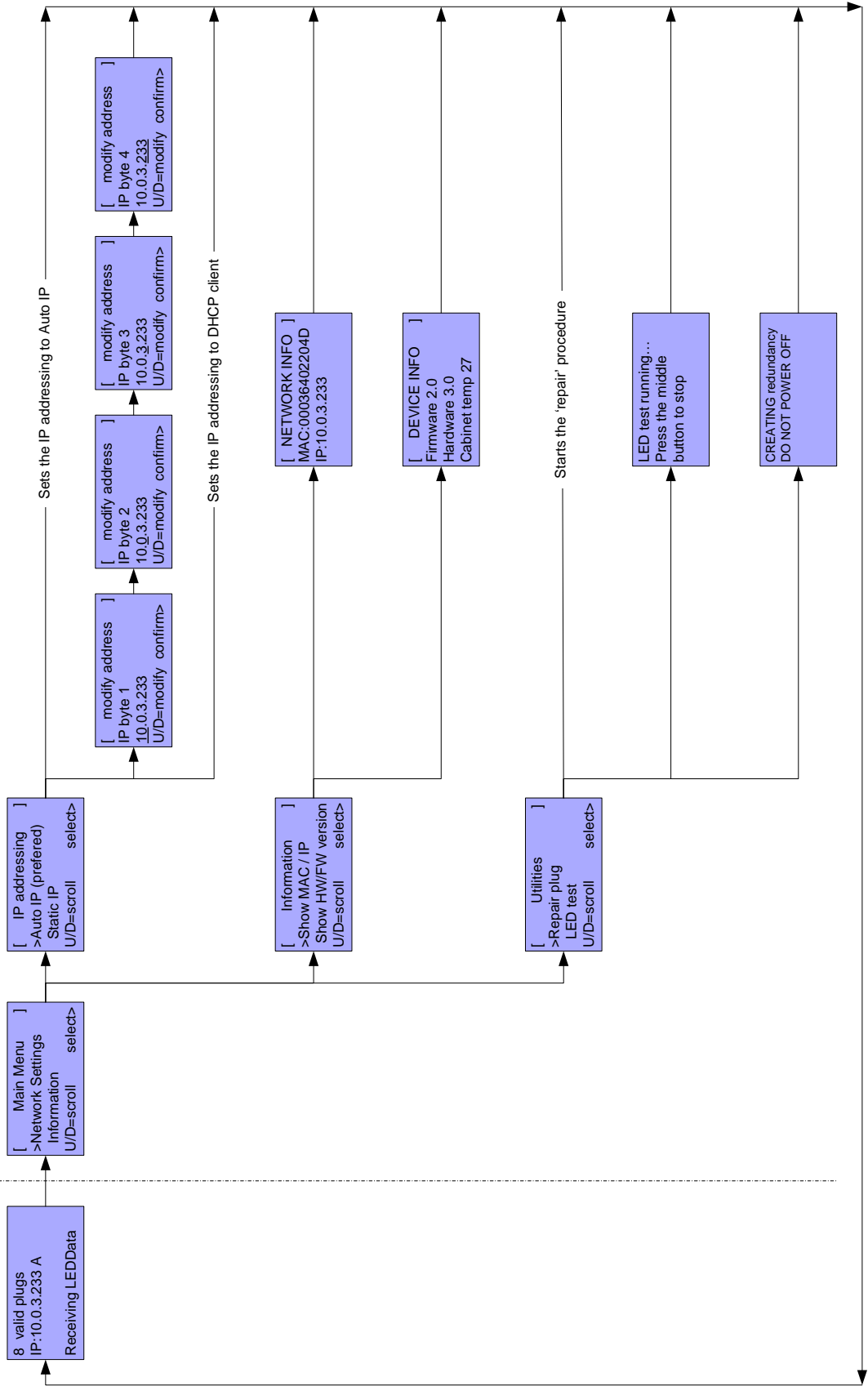

Technical Specifications

Input

- Supply voltage: 90 .. 250 Vac
- Line frequency: 50 .. 60 Hz
- Input current: 4.4 A (@115Vac) / 2.4 A (@230Vac)
- Input power: 450 Watt
- Fuses, slow blow, 6.3A, 20x5mm
- Mains input: standardized IEC power inlet
- PFC (Power Factor Correction) circuit present

LED Outputs (8 XLRs in total, each output can drive 128 LEDs)

- Output Voltage: 24 V
- Total Output Power: 400 Watt

Data Ports

- Ethernet port 10/100 Mbps

Environmental

- Operating temperature, humidity*: 0°C .. +50°C, < 80% RH
- Storage temperature, humidity*: 0°C .. +50°C, < 60% RH

(* non-condensing)

Mechanical

- Dimensions: 483 x 88 x 138 mm (19' rack mountable)
- Weight: 3.32 kg

Declaration of conformity

We, ShowLED FZC

Sharjah International Airport Free Zone, Sharjah, UAE

Declare that the product

ShowLED Animation System

is in conformity with the essential requirements of the following directives and standards:

Low Voltage Directive (73/23/EEC)

IEC 60065, 12-2005 (Edition 7.1)

Audio, video and similar electronic apparatus – Safety requirements

EMC Directive (89/336/EEC and 92/31/EEC)

EN 55103-1, 11-1996 Electromagnetic compatibility for audio, video, audio-visual and entertainment lighting control apparatus for professional use.

Part 1: Emission

EN 55103-2, 11-1996 Electromagnetic compatibility for audio, video, audio-visual and entertainment lighting control apparatus for professional use.

Part 2: Immunity

EN 55022 Standards of radio disturbance of information technology equipment

Sharjah, UAE

Jimmy Pieters, R&D Manager



01/09/2011

(Date of issue)

(Signature of authorised person)

Chapter 3: The ShowLEditor

Software download

The ShowLED software can be downloaded from the ShowLed website:

www.showled.com/downloads

There are 2 applications that you need to install: the ShowLEditor and the LED filter application.

When you've installed all the necessary software you need to configure your PC in the correct way as described below.

Configuring the PC's IP address (Windows XP)

1. Make sure your laptop or PC has a fixed IP address. Here is how you can do this.

- Start Control Panel
- In Control Panel, start Network Connections, this is what you will see:

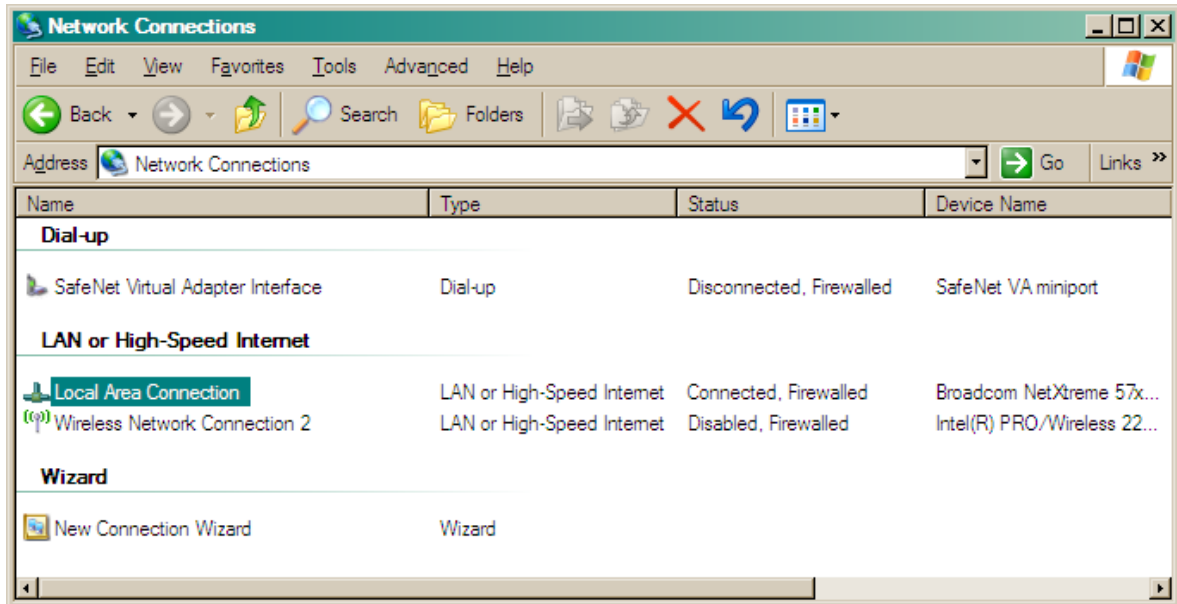

- Start Local Area Connection and you get:

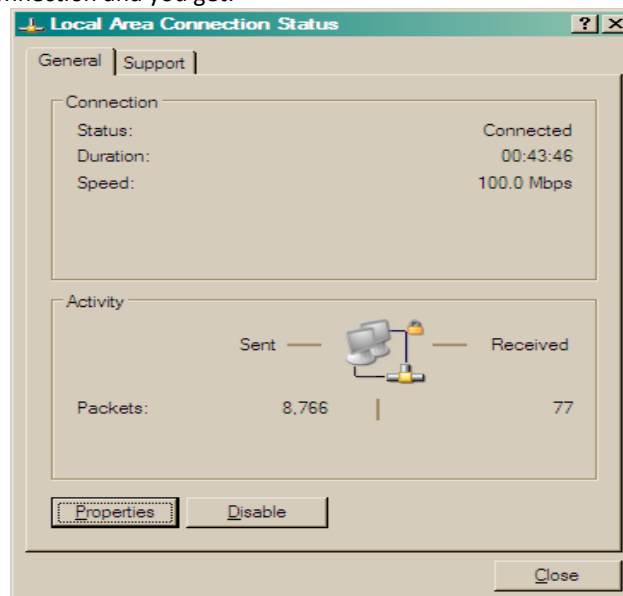

- Click on the Properties button and you get:

- Look for Internet Protocol (TCP/IP) in the list, doubleclick on the item, and you will get:

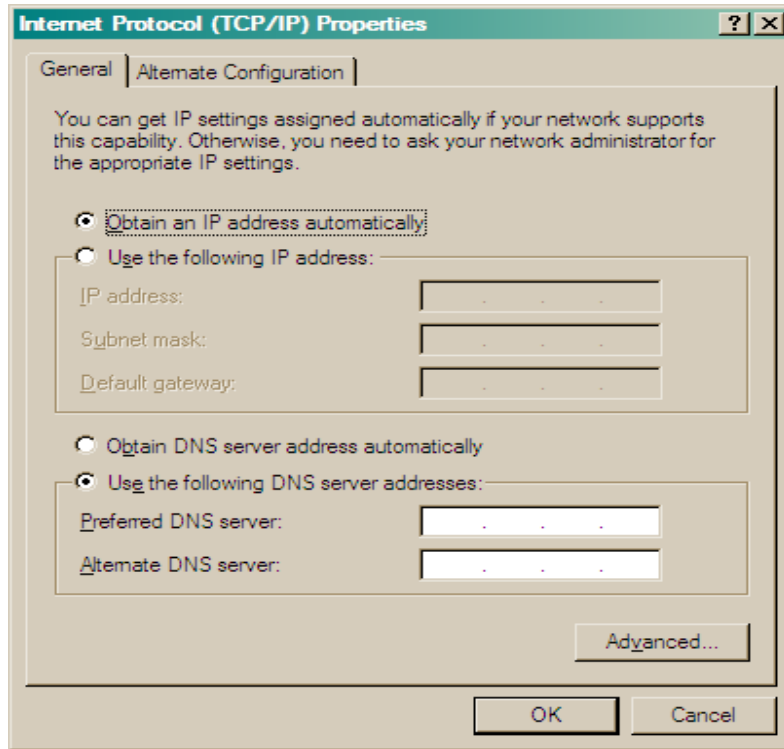

- Enter the following data into the screen:

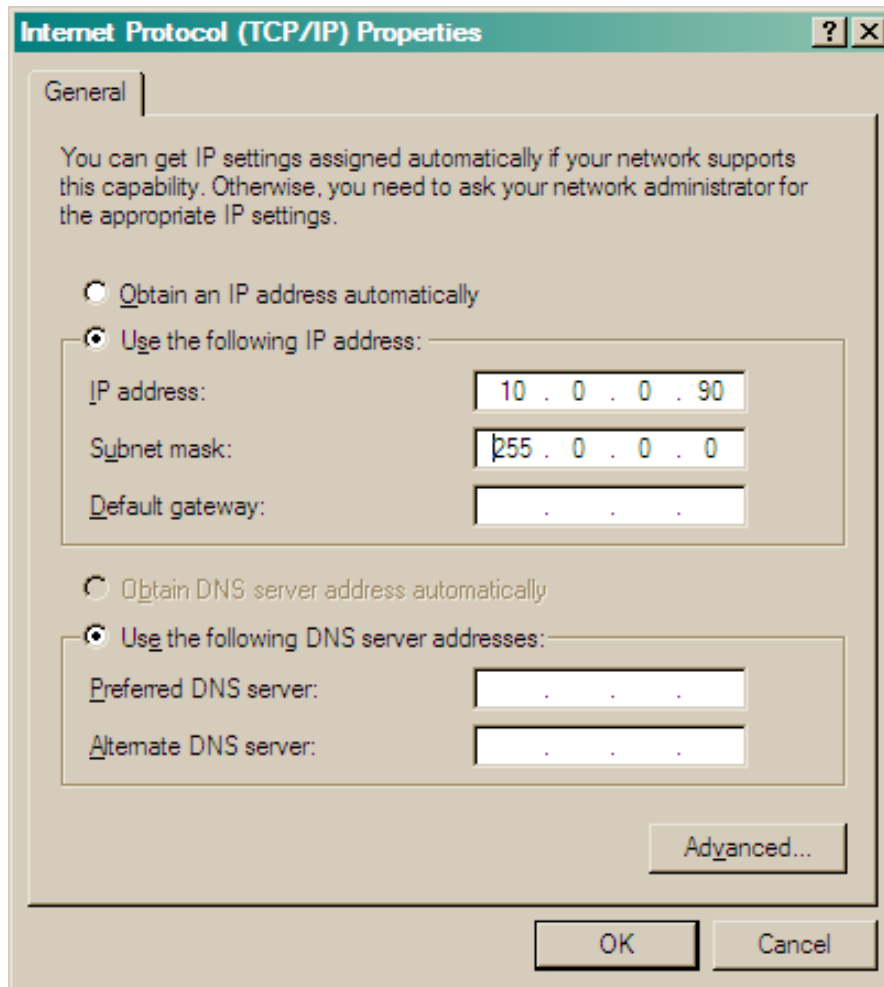

- The IP address must be in the range of 10.0.0.x
- Click OK and close all windows. This may take some time. Restart your laptop or PC.

Configuring the PC's IP address (Windows Vista)

Double click on the Internet connection icon located in the bottom right corner of your desktop and click on "Network and Sharing Centre". .



The following window will open. Please click on "Manage network connections" in the far left corner.

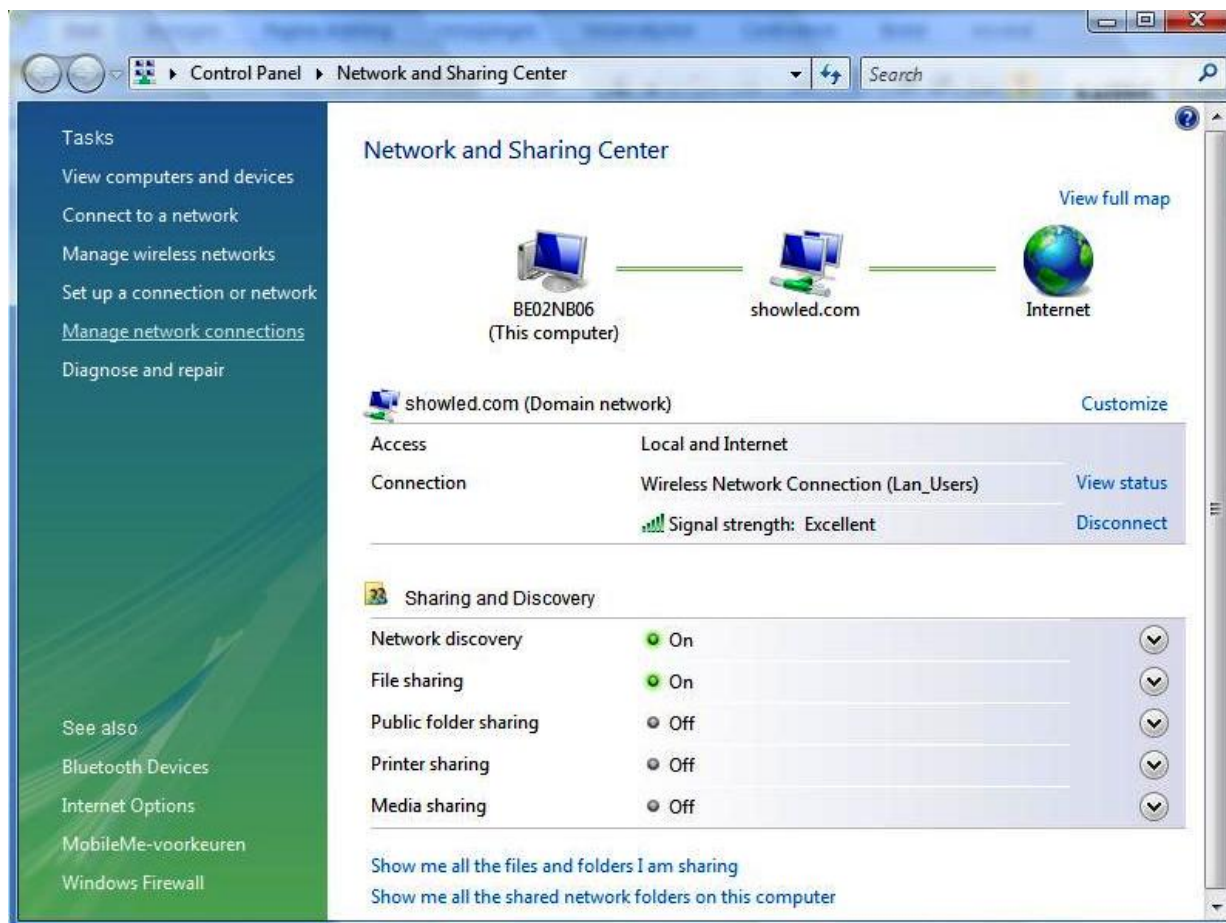

This will open following window.

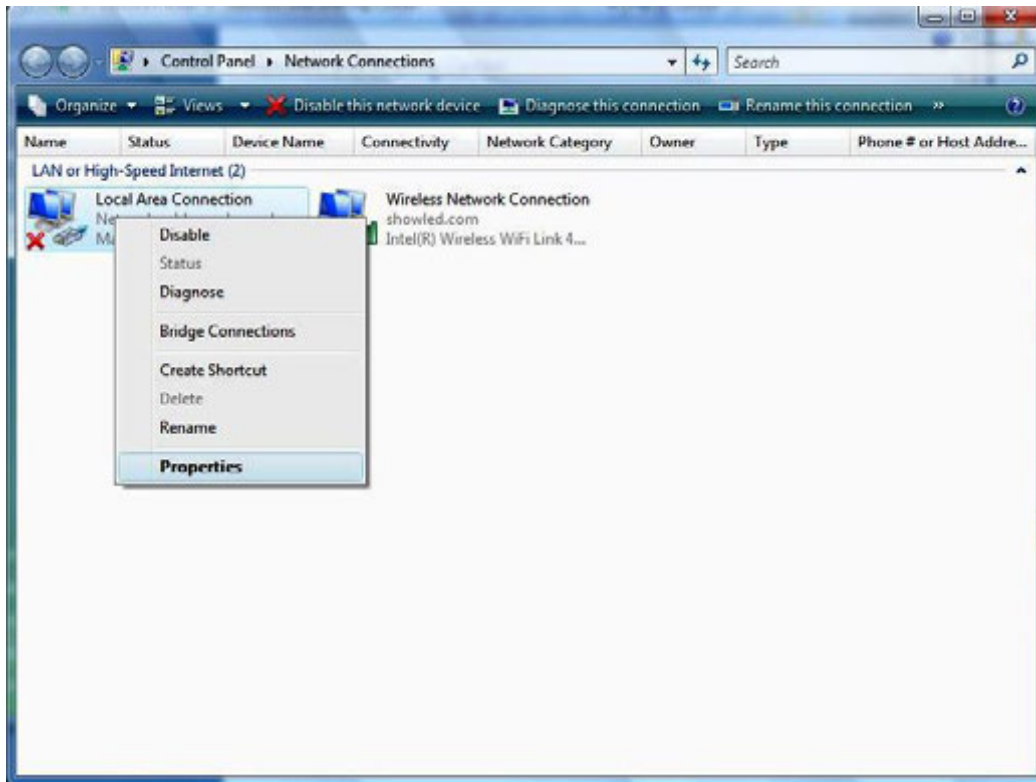

Right click on “Local Area Connection” and select “properties”.

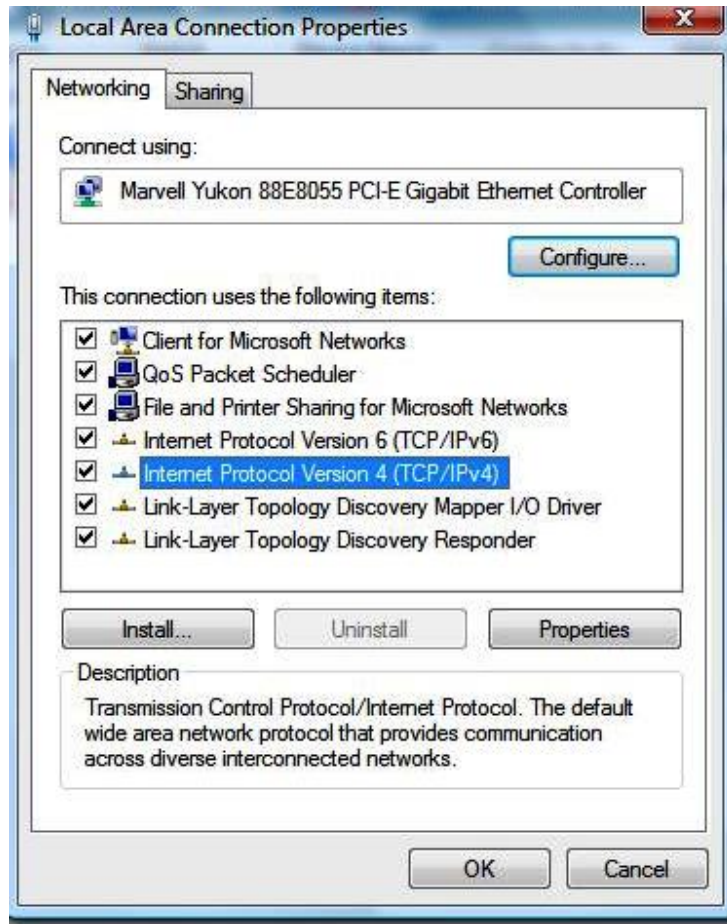

Select "Internet Protocol Version 4" and click on "properties"

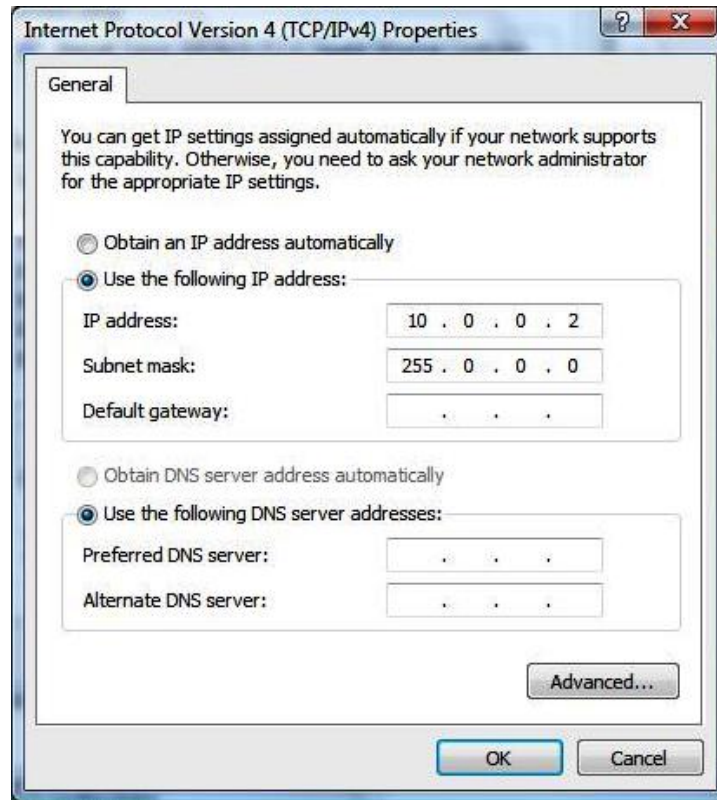

In the properties window you need to tick the box in front of “use following IP address” and you need to fill in the value 10.0.0.2 . The subnet mask value will be set automatically to 255. 0 . 0 . 0 .

Click ok and restart your PC. It’s recommended to turn off Windows firewall and to run all the software as administrator

ShowLEditor software.

Start the file C:\program files\showled\showleditor.exe and this is what you'll see.



In this example 3 x 4m x 9m ShowLED Animation starcloths are connected to the PC. The software automatically detects these backdrops and they are listed in the "Cloth store" view.

The starcloths that are connected to the PC will light up and will be divided in red and green squares.

You can easily select the curtains by clicking on them in the "cloth store" view. The selected starcloth will have a blue outline around the green and red squares.

You can now rotate the selected cloths in the "cloth store" by pressing the "Rotate 90" key. The aim is to rotate the cloth until the red and green square are divided in the same way as on the physical backdrop.

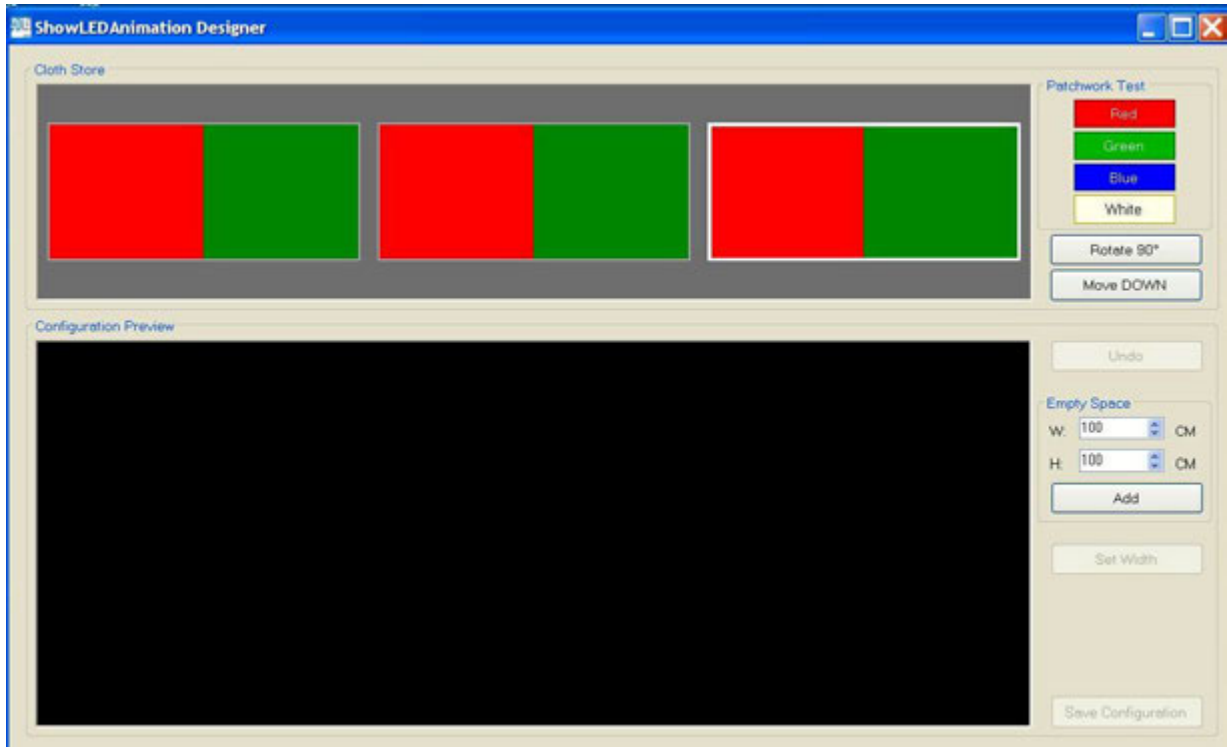

Once all the starcloths are rotated in the correct way you can move them down to the “configuration preview” by pressing the “move down” button. Make sure that you move the ShowLED Animation starcloth down from left to right. So the first starcloth at the left side should be the first cloth to be moved down.



If this is your final configuration you can save it by pressing the “save configuration” button.

If you have a configuration with multiple lines of curtains (e.g. a total setup of 10m x 28m made out of 5m x 7m starcloths) you can easily add a new row by pressing the “set width” button.

Please note that you can easily undo your last move by pressing the “undo” button.

Empty spaces

You also have the possibility to insert “empty spaces”. Empty spaces are virtual curtains you can insert in the configuration to increase the total surface of the projection area.

If you want to position the curtains far away from each other, if there are objects between curtains (doors, projection screens,...) or if you want to make a special configuration you can apply this empty spaces function.

You can also use the empty space function when you have Animation curtains of different sizes you want to use as a whole (e.g. if you join a 4m x 9m curtain and a 5m x 7m curtains you can add an empty space on top of the 4m x 9m curtain so it becomes virtually 5m x 9m).

The software regards the empty spaces as extra curtains, this way animations will run very smoothly over different curtains instead of jumping from one to the other.

The empty spaces will always be added on the right of the last starcloth you have moved down.

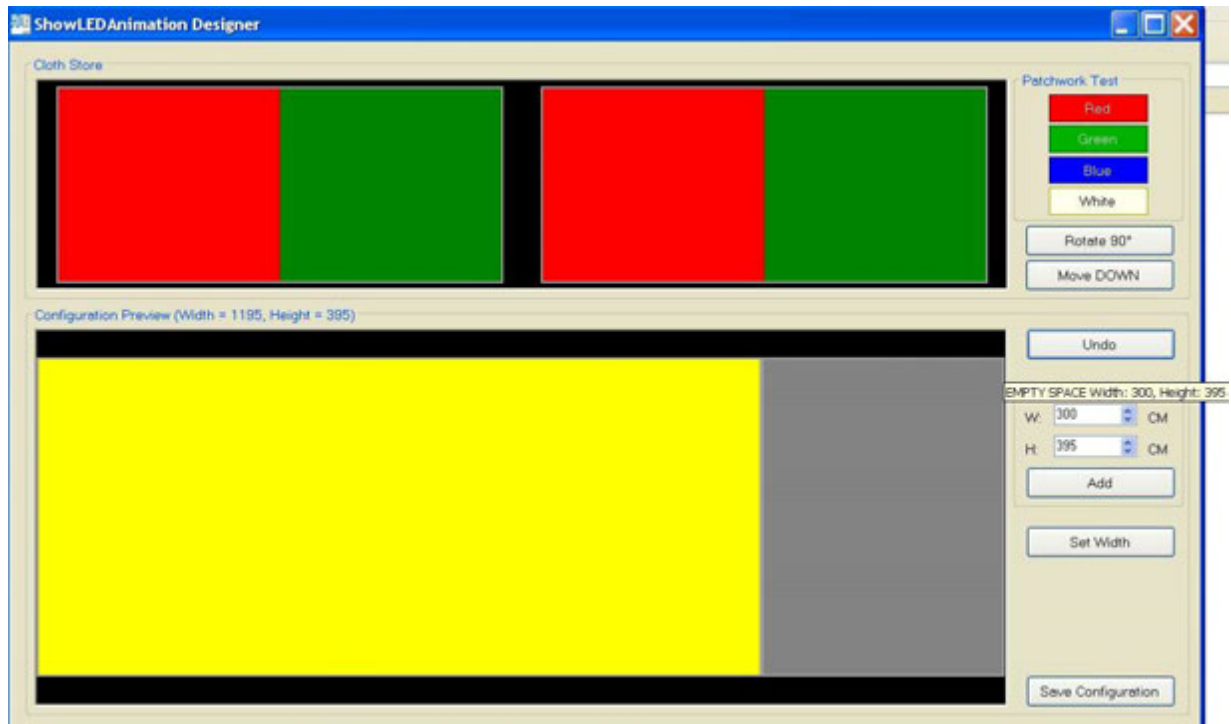

In the above picture for instance there's an empty space of 3m wide inserted behind the first starcloth.

Then you can just continue adding starcloths and empty spaces as shown the next picture.



When you're done just save the configuration file.

If you have to starcloths of a different dimension for example a 5m x 7m Animation backdrop and a 4m x 9m Animation cloth that are ^placed next to each other you don't need to add an empty space. The software will detect the empty space automatically when you save the configuration.

Error notices

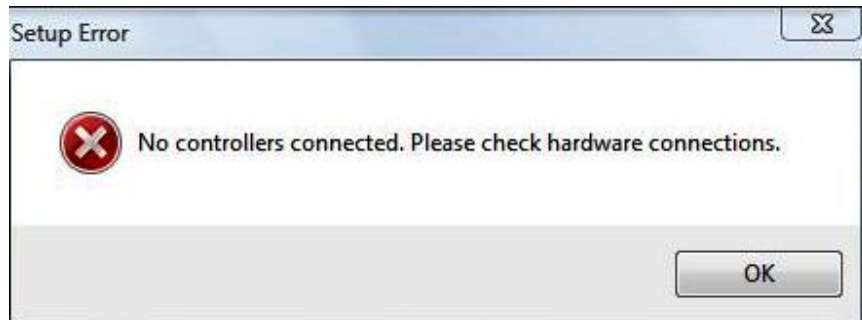

This means that the designer software cannot detect the controllers. There are different reasons possible for this error.

- The controllers are not switched on.
- The LAN cable is not plugged in correctly.
- The Lan cable is damaged.
- The IP address of your PC is not configured correctly.

Chapter 4: The V-Box

The V-box three step set-up: 1 Connect - 2 Upload - 3 Play



1. Connect the cables.

On the Rear:

Connect the power plug

On the Front:

Connect to the control network with the Ethernet plug.

Connect a video source to one of your choice (CVBS, S-Video or VGA¹).

Keep the cables that connect the video source as short as possible.

Use high quality cables.

2. Make and upload your configuration.

Create the configuration file of your installed patchwork with the ShowLED Designer or the ShowLEDitor application.

Power up the V-box.

Upload the configuration with a TFTP client application.

(more information on the next page(s))

Disconnect the PC when you're done.

3. Select video source and start playing.

Use the 'Select' button to select the Video input source that you want to work with.

Note: The LED on the right of the select input will start flashing when a valid video signal is applied.

Now you are ready to play with it.

¹ Resolution 800x600 – refresh 60Hz

How to upload the configuration file to the V-box?

Prerequisite

1. Obtain a free copy of "TFTP client" from http://download.cnet.com/TFTP-Desktop/3000-2085_4-10073951.html
2. Install the program

Usage

0. Start the program "TFTP client"
1. Fill in the IP address of the V-box, this should be 10.128.0.1
2. Choose for operation "upload"
3. The format is set to binary
4. Locate your configuration file (name.slc)
5. Click on "Upload now"



Note: Do not alter the default settings (as shown below)

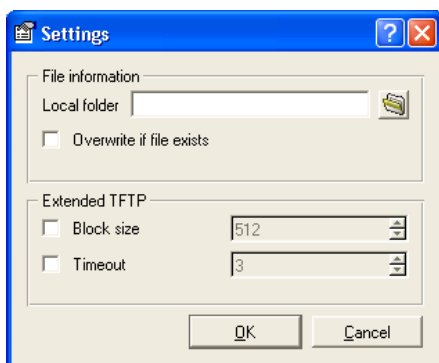

OR...

You can always use the build-in TFTP client from Microsoft.

(Accessible from the command line)

command line: `tftp -i 10.128.0.1 put C:\YOURDIRECTORY\yourpatchworkname.slc`

Troubleshooting V-box upload problem

Checklist

1. Make sure that the local area connection on the PC has a static IP address and is part of Class-A network (for example IP 10.0.0.2 / Subnet 255.0.0.0).



If your O.S. support both IP4 and IP6 make sure that you change this for IP4.

2. Disable the Windows firewall or any other third party firewall.
3. Disable your wireless connection.
4. Check your connection by pinging the V-box (command line: ping 10.128.0.1)
5. Upload your file

Notes:

Try to use a PC that runs Windows in native mode, because some virtualisation software packages limit the access to the LAN controller.

If you want to use the build-in TFTP client from Microsoft, you need to install it in some cases (for instance in Vista Home edition)