

RTD 1100

TECHNICAL DATA SHEET

July 2019

The RTD 1100 is a budget friendly track motor for basic motorised track control, ideal for simple rope operation, as used for fixed installations in theatres and venues.

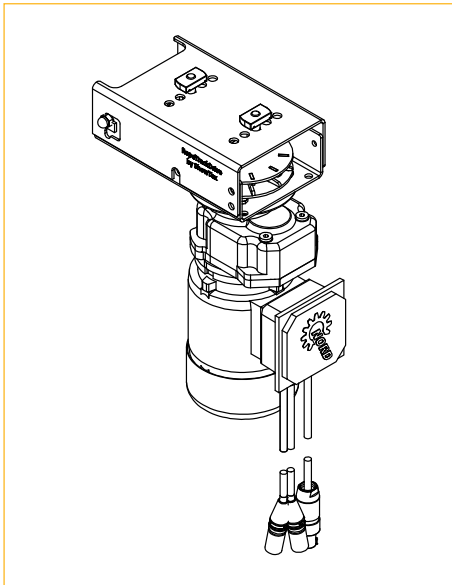

» SPECIFICATIONS

- Built up in 2 major parts: Rope transmission and Motor
- All connections are made with plugs which makes it easy for touring and installation
- Works with H100, ShowPipe and ShowTrack rail systems
- Fixed speed of 42 cm/sec
- Equipped with an easy-to-use remote control with open & close
- Open & close can be controlled by DMX

» INSTALLATION SPECIFICATIONS

- Power Supply : 1 x 230 VAC - 50 Hz - 4.8 A
- Power Connection : Schuco Means Connector

» OPERATIONAL SPECIFICATIONS

- Speed : Fixed Speed
- Remote Control : Open - Close
- DMX : 2 Channels: Open - Close

» **OUTER DIMENSIONS (MM)**

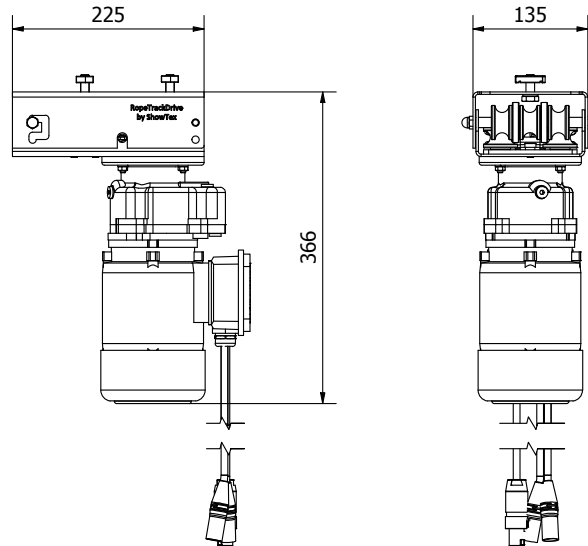

» **ELECTRICAL AND MECHANICAL SPECIFICATIONS**

- Motor torque: 11 Nm
- Motor speed: 106 rpm
- Maximum rope force: 275 N
- Rope speed: 42 cm/sec
- Motor Power: 120 W
- Power in: 1 x 230 VAC
- Power connection: 20A - PowerCON
- Duty cycle: S1 - Continuous Duty

» ELECTRICAL WIRING & CONNECTORS

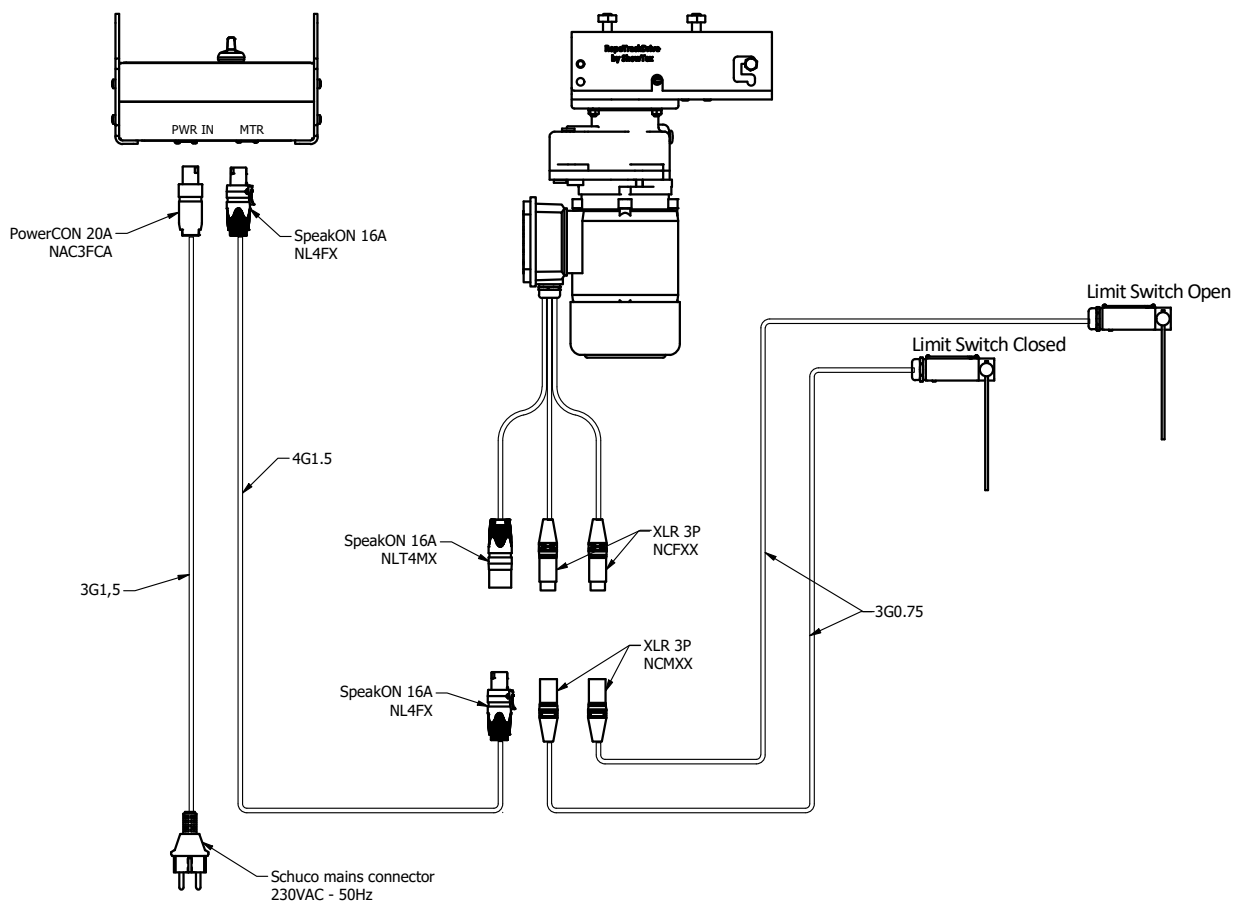

» ELECTRICAL WIRING & CONNECTORS FOR DMX CONTROL

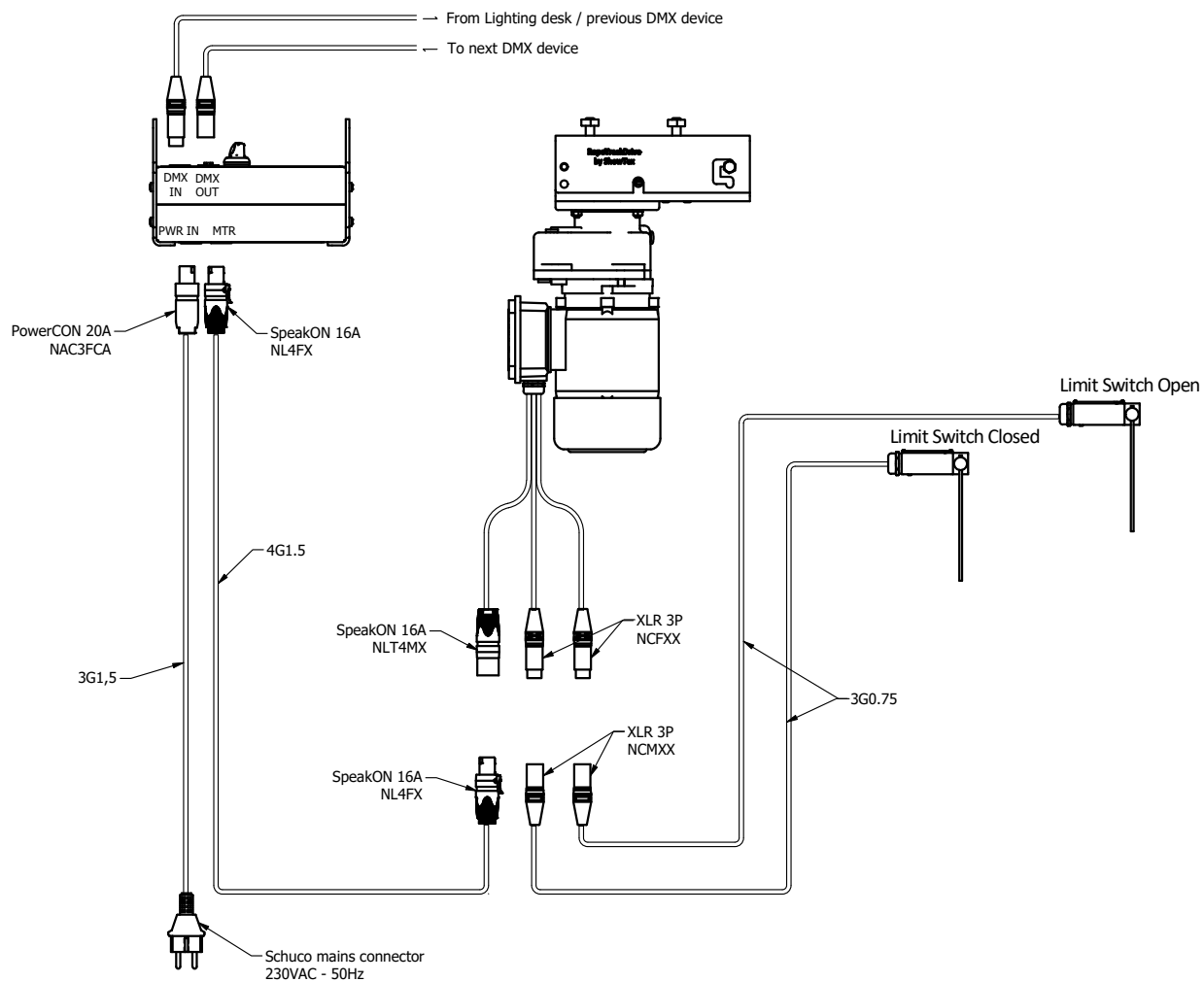

» COMPONENTS (MM)

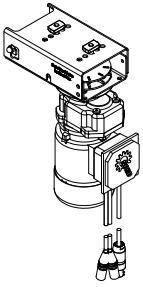
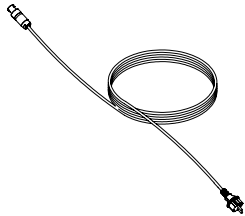
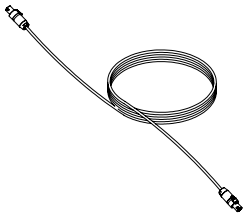
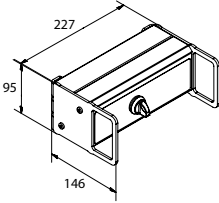
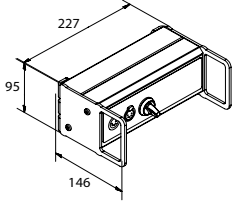
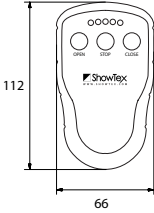
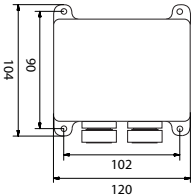
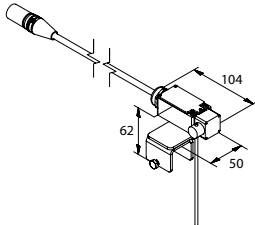
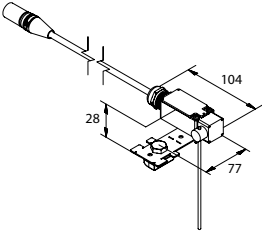
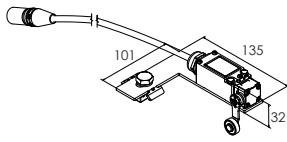
	<p>1. RTD 1100 motor</p> <table border="1"> <thead> <tr> <th>Article code</th> <th>Colour</th> </tr> </thead> <tbody> <tr> <td>8050 0713 2227</td> <td>Black</td> </tr> <tr> <th>Info</th> <th>Weight</th> </tr> <tr> <td>120 W-1x230 VAC 4.8A - 106rpm With cables and plugs</td> <td>11.8 kg/m</td> </tr> </tbody> </table>	Article code	Colour	8050 0713 2227	Black	Info	Weight	120 W-1x230 VAC 4.8A - 106rpm With cables and plugs	11.8 kg/m		<p>2. Power Supply Cable</p> <table border="1"> <thead> <tr> <th>Article code</th> <th>Colour</th> </tr> </thead> <tbody> <tr> <td>8150 0912 0027</td> <td>Black</td> </tr> <tr> <th>Info</th> <th>Weight</th> </tr> <tr> <td>2 m</td> <td>0.40 kg/pc</td> </tr> </tbody> </table>	Article code	Colour	8150 0912 0027	Black	Info	Weight	2 m	0.40 kg/pc
Article code	Colour																		
8050 0713 2227	Black																		
Info	Weight																		
120 W-1x230 VAC 4.8A - 106rpm With cables and plugs	11.8 kg/m																		
Article code	Colour																		
8150 0912 0027	Black																		
Info	Weight																		
2 m	0.40 kg/pc																		
	<p>3. Link Cable</p> <table border="1"> <thead> <tr> <th>Article code</th> <th>Colour</th> </tr> </thead> <tbody> <tr> <td>8160 0915 0257</td> <td>Black</td> </tr> <tr> <th>Info</th> <th>Weight</th> </tr> <tr> <td>25 m</td> <td>3.39 kg/pc</td> </tr> </tbody> </table>	Article code	Colour	8160 0915 0257	Black	Info	Weight	25 m	3.39 kg/pc		<p>4. Remote unit RTD 1100</p> <table border="1"> <thead> <tr> <th>Article code</th> <th>Colour</th> </tr> </thead> <tbody> <tr> <td>8050 0950 0007</td> <td>Black</td> </tr> <tr> <th>Info</th> <th>Weight</th> </tr> <tr> <td></td> <td>1.55 kg/pc</td> </tr> </tbody> </table>	Article code	Colour	8050 0950 0007	Black	Info	Weight		1.55 kg/pc
Article code	Colour																		
8160 0915 0257	Black																		
Info	Weight																		
25 m	3.39 kg/pc																		
Article code	Colour																		
8050 0950 0007	Black																		
Info	Weight																		
	1.55 kg/pc																		
	<p>5. RTD 1100 DMX Basic Module</p> <table border="1"> <thead> <tr> <th>Article code</th> <th>Colour</th> </tr> </thead> <tbody> <tr> <td>8050 0766 0200</td> <td>Black</td> </tr> <tr> <th>Info</th> <th>Weight</th> </tr> <tr> <td>optional</td> <td>1.92 kg/pc</td> </tr> </tbody> </table>	Article code	Colour	8050 0766 0200	Black	Info	Weight	optional	1.92 kg/pc		<p>6. RF Remote</p> <table border="1"> <thead> <tr> <th>Article code</th> <th>Colour</th> </tr> </thead> <tbody> <tr> <td>8050 0950 0200</td> <td></td> </tr> <tr> <th>Info</th> <th>Weight</th> </tr> <tr> <td>optional 2.4 GHz radio range: up to 700m (open space)</td> <td>0.14 kg/pc</td> </tr> </tbody> </table>	Article code	Colour	8050 0950 0200		Info	Weight	optional 2.4 GHz radio range: up to 700m (open space)	0.14 kg/pc
Article code	Colour																		
8050 0766 0200	Black																		
Info	Weight																		
optional	1.92 kg/pc																		
Article code	Colour																		
8050 0950 0200																			
Info	Weight																		
optional 2.4 GHz radio range: up to 700m (open space)	0.14 kg/pc																		
	<p>7. RF Receiver</p> <table border="1"> <thead> <tr> <th>Article code</th> <th>Colour</th> </tr> </thead> <tbody> <tr> <td>8050 0950 0300</td> <td></td> </tr> <tr> <th>Info</th> <th>Weight</th> </tr> <tr> <td>optional 5 channels</td> <td>0.32 kg/pc</td> </tr> </tbody> </table>	Article code	Colour	8050 0950 0300		Info	Weight	optional 5 channels	0.32 kg/pc		<p>8. Limit Switch Set (Rail H100)</p> <table border="1"> <thead> <tr> <th>Article code</th> <th>Colour</th> </tr> </thead> <tbody> <tr> <td>8050 0770 0020</td> <td>Black</td> </tr> <tr> <th>Info</th> <th>Weight</th> </tr> <tr> <td>For Rail H100 2 pieces with 25 m cable</td> <td>0.23 kg/pc</td> </tr> </tbody> </table>	Article code	Colour	8050 0770 0020	Black	Info	Weight	For Rail H100 2 pieces with 25 m cable	0.23 kg/pc
Article code	Colour																		
8050 0950 0300																			
Info	Weight																		
optional 5 channels	0.32 kg/pc																		
Article code	Colour																		
8050 0770 0020	Black																		
Info	Weight																		
For Rail H100 2 pieces with 25 m cable	0.23 kg/pc																		
	<p>9. Limit Switch Set (ShowPipe)</p> <table border="1"> <thead> <tr> <th>Article code</th> <th>Colour</th> </tr> </thead> <tbody> <tr> <td>8050 0770 0010</td> <td>Black</td> </tr> <tr> <th>Info</th> <th>Weight</th> </tr> <tr> <td>For ShowPipe 2 pieces with 25 m cable</td> <td>0.23 kg/pc</td> </tr> </tbody> </table>	Article code	Colour	8050 0770 0010	Black	Info	Weight	For ShowPipe 2 pieces with 25 m cable	0.23 kg/pc		<p>10. Limit switch set (ShowTrack)</p> <table border="1"> <thead> <tr> <th>Article code</th> <th>Colour</th> </tr> </thead> <tbody> <tr> <td>8050 0770 0013</td> <td>Black</td> </tr> <tr> <th>Info</th> <th>Weight</th> </tr> <tr> <td>For ShowTrack 2 pieces with 25 m cable</td> <td>0.23 kg/m</td> </tr> </tbody> </table>	Article code	Colour	8050 0770 0013	Black	Info	Weight	For ShowTrack 2 pieces with 25 m cable	0.23 kg/m
Article code	Colour																		
8050 0770 0010	Black																		
Info	Weight																		
For ShowPipe 2 pieces with 25 m cable	0.23 kg/pc																		
Article code	Colour																		
8050 0770 0013	Black																		
Info	Weight																		
For ShowTrack 2 pieces with 25 m cable	0.23 kg/m																		

HAVE A GREAT SHOW!
MORE INFO ON WWW.SHOWTEX.COM